

SMB Straight Bulkhead Receptacle Jack  
Coaxial End

SMB2FA50-1460A/11

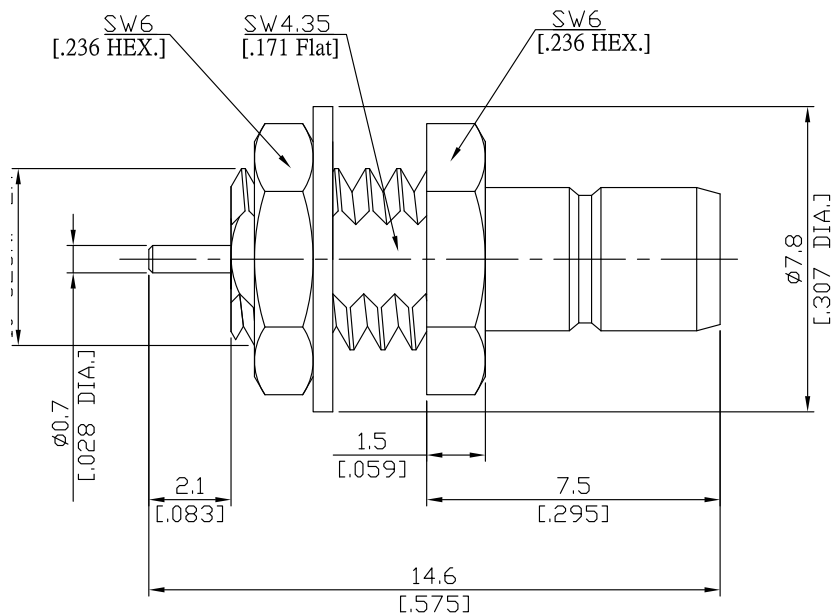

All dimensions are in mm [inch]  
Tolerances according to DIN ISO 2768-mH

**Interface**

According to IEC 60169-10; MIL-C-39012; MIL-STD-348A/311

**Electrical Data**

Impedance 50 Ω  
Frequency DC to 4 GHz

**Mechanical Data**

Coupling mechanisms Snap-on  
Weight 0.0012 kg

**Environmental Data**

Temperature range -65°C to +165°C  
RoHS compliant

**Material And Plating**

Piece Parts	Material	Plating
Centre contact	Brass	Gold plating(Nickel underplated)
Body	Brass	Gold plating(Nickel underplated)
Insulator	PTFE	
Fastening nut	Brass	Gold plating(Nickel underplated)
Washer	Brass	Gold plating(Nickel underplated)

**Packing**

Single or 100

**Related Document**

Mounting Dimension MD4