

SMA Straight Panel Receptacle Jack (Flat End)

SMA2GTD50-2755A/91

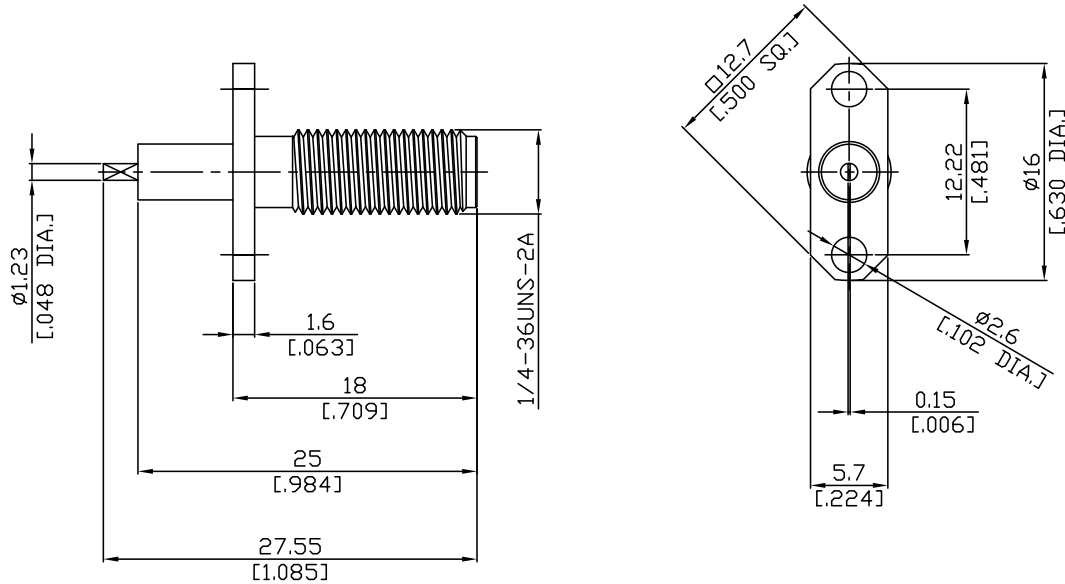

All dimensions are in mm [inch]

Tolerances according to DIN ISO 2768-mH

Interface

According to MIL-C-39012;MIL-STD-348A/310

Electrical Data

Impedance 50 Ω
 Frequency DC to 18 GHz
 VSWR (Return Loss) ≤ 1.25 (≥ 19.08 dB)
 Insertion Loss ≤ 0.05 x √F (GHz) dB

Mechanical Data

Coupling mechanisms Screw-lock
 Weight 0.0034 kg

Environmental Data

Temperature range -65°C to +165°C
 RoHS compliant

Material And Plating

Piece Parts	Material	Plating
Centre contact	Beryllium Copper	Gold plating(Nickel underplated)
Body	Brass	Gold plating(Nickel underplated)
Insulator	PTFE	

Packing

Single or 100

Related Document

Mounting Dimension MD75