

SMA Straight Panel Receptacle Jack (Coaxial End)

SMA2GFA50-1800A-EC/9X

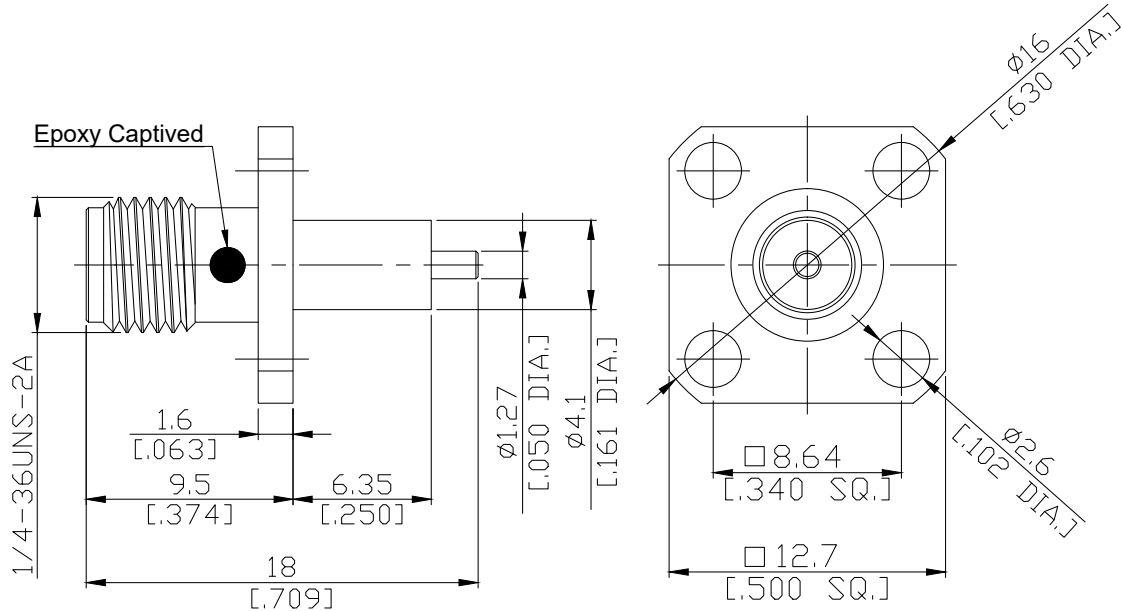

All dimensions are in mm [inch]
Tolerances according to DIN ISO 2768-mH

Interface
According to MIL-C-39012; MIL-STD-348A/310

Electrical Data
Impedance 50 Ω
Frequency DC to 18 GHz
VSWR (Return Loss) ≤ 1.25 (≥ 19.08 dB)
Insertion Loss ≤ 0.05 x √F (GHz) dB

Mechanical Data
Coupling mechanisms Screw-lock
Weight N/A

Environmental Data
Temperature range -65°C to +165°C
RoHS compliant

Material And Plating		
Piece Parts	Material	Plating
Centre contact	Beryllium Copper	Gold plating(Nickel underplated)
Body	Stainless Steel	Passivated
Insulator	PTFE	

Packing
Single or 100

Related Document
Mounting Dimension MD71