

2.4mm Straight Panel Receptacle Jack
Coaxial End

Q2GFA50-1980B/9X

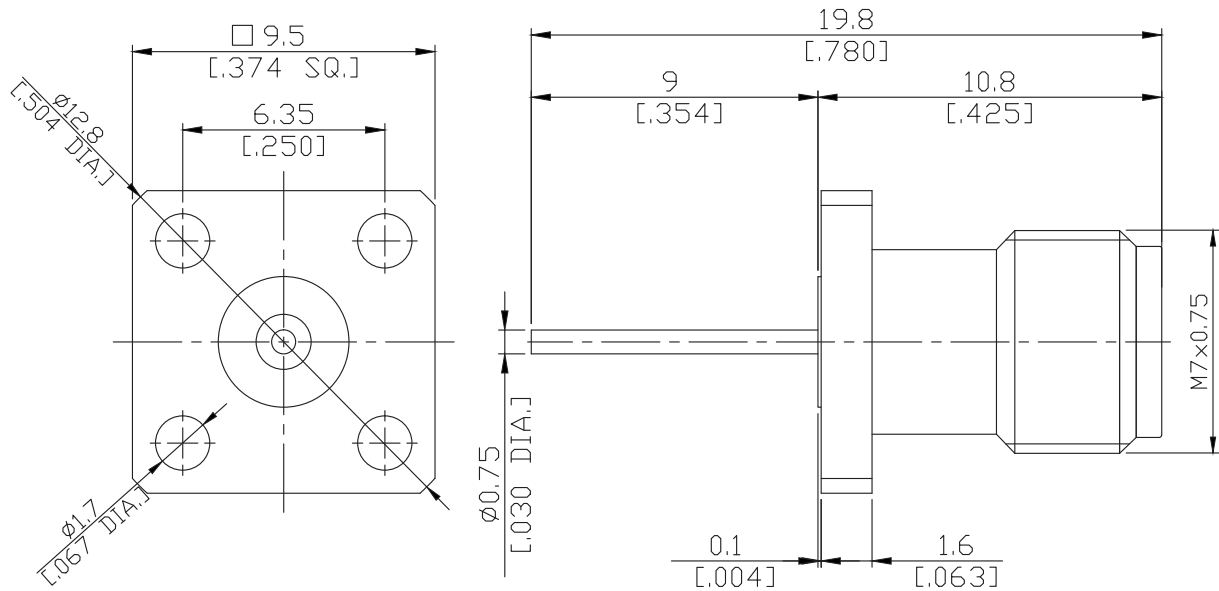

All dimensions are in mm [inch]

Interface

According to IEEE STD 287-2007

Electrical Data

Impedance 50 Ω
Frequency DC to 50 GHz
VSWR ≤1.15
Return loss ≥23.127dB

Mechanical Data

Coupling mechanisms Screw-lock
Weight N/A

Environmental Data

Temperature range -55°C to +165°C
RoHS compliant

Material And Plating

Piece Parts	Material	Plating
Centre contact	Beryllium Copper	Gold plating(Nickel underplated)
Body	Stainless Steel	Passivated
Insulator	PEI/PTFE	

Packing

Single or 100