

2.4mm Straight Panel Receptacle Jack  
Coaxial End

Q2GFA50-1980A/9X

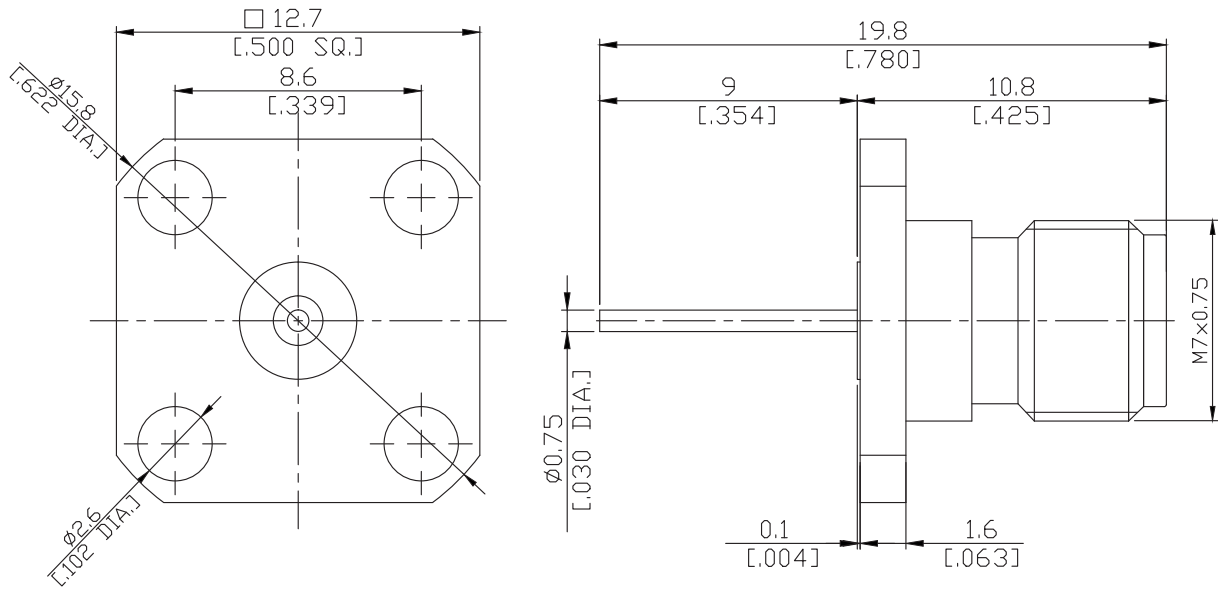

All dimensions are in mm [inch]

**Interface**

According to IEEE STD 287-2007

**Electrical Data**

Impedance 50  $\Omega$   
 Frequency DC to 50 GHz  
 VSWR  $\leq 1.15$   
 Return loss  $\geq 23.127$  dB

**Mechanical Data**

Coupling mechanisms Screw-lock  
 Weight N/A

**Environmental Data**

Temperature range -55°C to +165°C  
 RoHS compliant

**Material And Plating**

Piece Parts	Material	Plating
Centre contact	Beryllium Copper	Gold plating(Nickel underplated)
Body	Stainless Steel	Passivated
Insulator	PEI/PTFE	

**Packing**

Single or 100