

2.4mm Straight Panel Receptacle Jack
Coaxial End

Q2GFA50-1530A/9X

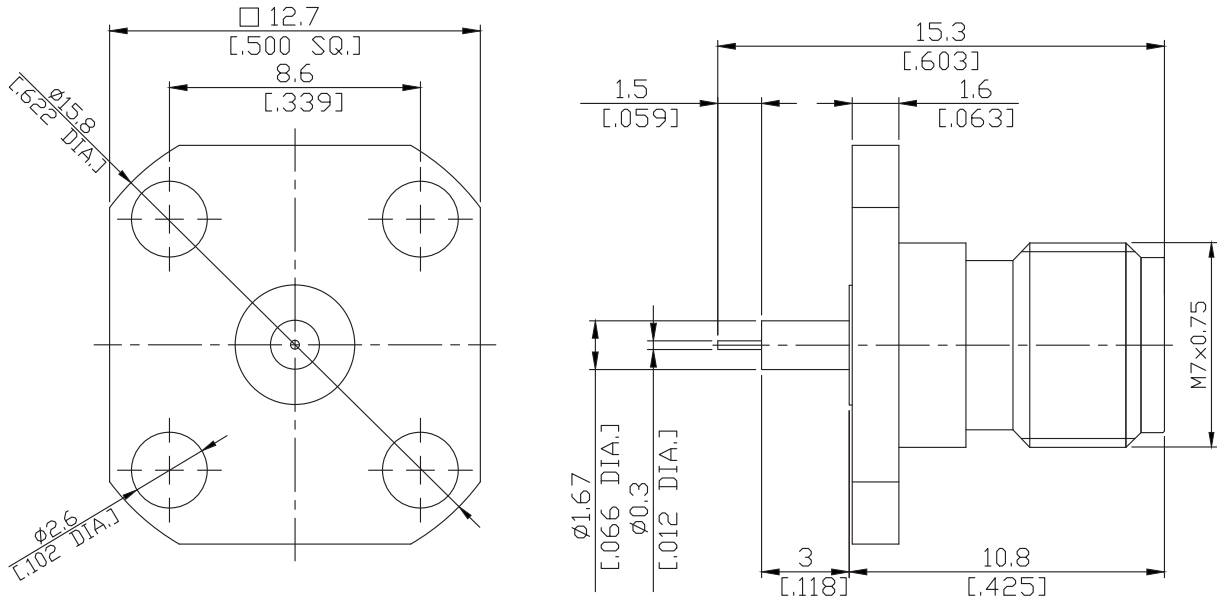

All dimensions are in mm [inch]

Interface

According to **IEEE STD 287-2007**

Electrical Data

Impedance **50 Ω**
 Frequency **DC to 50 GHz**
 VSWR **≤1.15**
 Return loss **≥23.127dB**

Mechanical Data

Coupling mechanisms **Screw-lock**
 Weight **N/A**

Environmental Data

Temperature range **-55°C to +165°C**
 RoHS **compliant**

Material And Plating

Piece Parts	Material	Plating
Centre contact	Beryllium Copper	Gold plating(Nickel underplated)
Body	Stainless Steel	Passivated
Insulator	PEI/PTFE	

Packing

Single or 100