

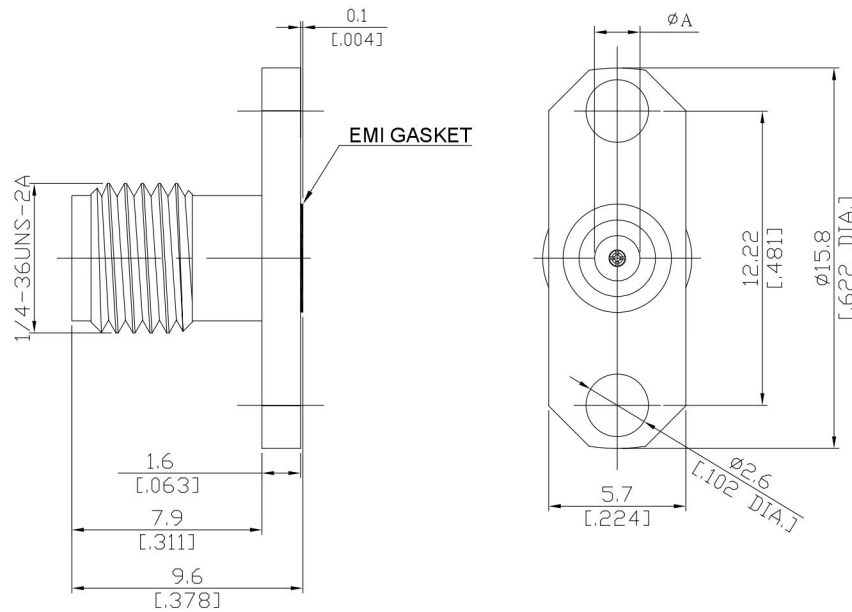

Precision SMA
Straight Field Replaceable Jack

PCA2BT50-0018D/9X



P/N	Accept Pin mm [inch]	Max. Pin Depth mm [inch]	Ø A mm [inch]
PCA2BT50-0020D/9X	0.51 [0.020]	2.54 [0.100]	2.67 [0.105]
PCA2BT50-0018D/9X	0.46 [0.018]	2.54 [0.100]	2.59 [0.102]
PCA2BT50-0015D/9X	0.38 [0.015]	2.54 [0.100]	1.96 [0.077]
PCA2BT50-0012D/9X	0.30 [0.012]	1.90 [0.075]	1.96 [0.077]
PCA2BT50-0009D/9X	0.23 [0.009]	1.65 [0.065]	1.52 [0.060]

All dimensions are in mm [inch]

Tolerances according to DIN ISO 2768-mH

Interface

According to IEC 60169-15; MIL-C-39012; MIL-STD-348A/310

Electrical Data

Impedance 50 Ω
Frequency DC to 27 GHz
VSWR (Return loss) ≤ 1.15 (≥ 23.13)

Mechanical Data

Coupling mechanisms Screw-lock
Weight N/A
Accept Pin 0.46 mm (.018 inch)

Environmental Data

Temperature range -55°C to +165°C
RoHS compliant

Material And Plating

Piece Parts	Material	Plating
Centre contact	Beryllium Copper	Gold plating(Nickel underplated)
Body	Stainless Steel	Passivated
Insulator	PTFE	

Packing

Single or 100