

Precision SMA Straight
Field Replaceable Jack

PCA2BF50-0018B/9X

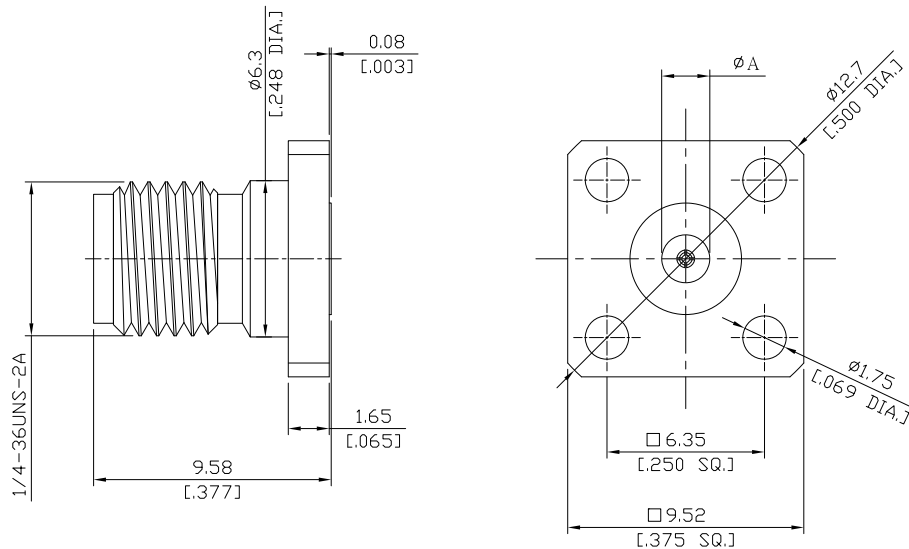

P/N	Accept Pin mm [inch]	Max. Pin Depth mm [inch]	ØA mm [inch]
PCA2BF50-0036B/9X	0.91 [.036]	2.54 [.100]	3.91 [.154]
PCA2BF50-0020B/9X	0.51 [.020]	2.54 [.100]	2.67 [.105]
PCA2BF50-0018B/9X	0.46 [.018]	2.54 [.100]	2.59 [.102]
PCA2BF50-0015B/9X	0.38 [.015]	2.54 [.100]	1.96 [.077]
PCA2BF50-0012B/9X	0.30 [.012]	1.90 [.075]	1.96 [.077]
PCA2BF50-0009B/9X	0.23 [.009]	1.65 [.065]	1.52 [.060]

All dimensions are in mm [inch]

Tolerances according to DIN ISO 2768-mH

Interface

According to IEC 60169-15; MIL-C-39012; MIL-STD-348A/310; CECC 22110

Electrical Data

Impedance 50 Ω
Frequency DC to 27 GHz

Mechanical Data

Coupling mechanisms Screw-lock
Weight N/A

Environmental Data

Temperature range -65°C to +165°C
RoHS compliant

Material And Plating

Piece Parts	Material	Plating
Centre contact	Beryllium Copper	Gold plating(Nickel underplated)
Body	Stainless Steel	Passivated
Insulator	PTFE	

Packing

Single or 100