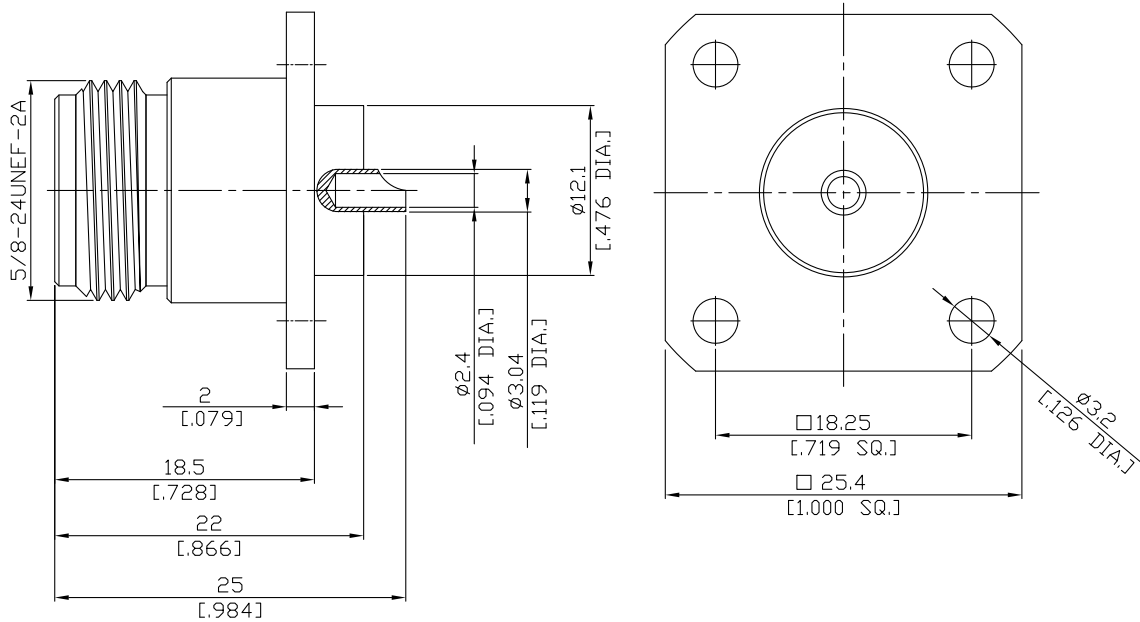

**N Straight Panel Receptacle Jack
(Solder End)**
N2GFB50-2500A/H4

All dimensions are in mm [inch]
Tolerances according to DIN ISO 2768-mH

Interface

According to MIL-C-39012;MIL-STD-348A/304

Electrical Data

Impedance 50 Ω
Frequency DC to 11 GHz

Mechanical Data

Coupling mechanisms Screw-lock
Weight 0.0290 kg

Environmental Data

Temperature range -65°C to +165°C
RoHS compliant

Material And Plating

Piece Parts	Material	Plating
Centre contact	Phosphor Bronze	Gold plating(Nickel underplated)
Body	Brass	Copper-Tin-Zinc Alloy
Insulator	PTFE	

Packing

Single or 100

Related Document

Mounting Dimension MD16