

2.92mm Straight Panel Receptacle  
Jack

K2GFA50-1230B/9X

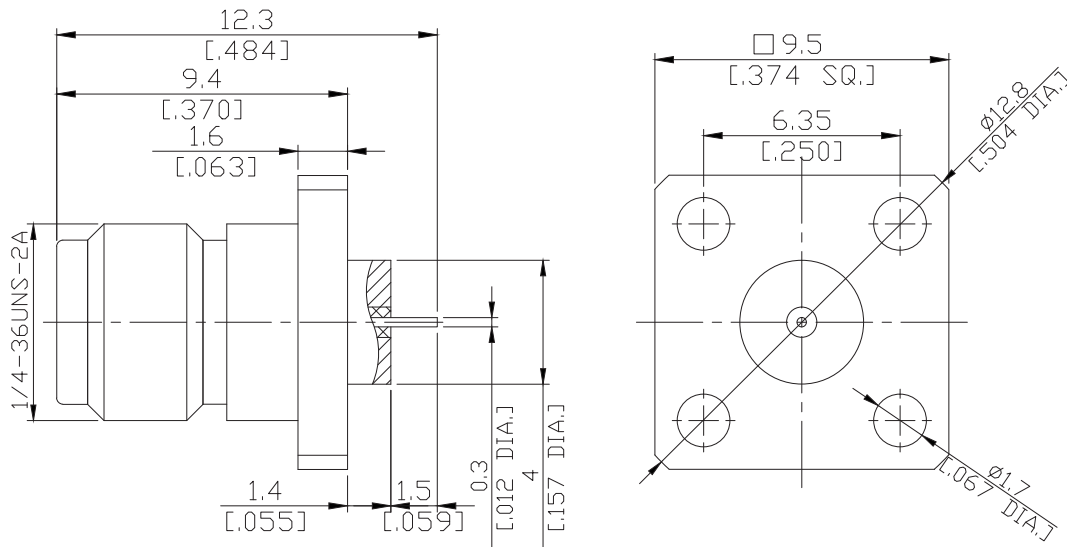

All dimensions are in mm [inch]

**Interface**

According to **MIL-STD-348A**

**Electrical Data**

Impedance 50 Ω  
 Frequency DC to 40 GHz  
 VSWR ≤1.15  
 Return loss ≥23.127dB

**Mechanical Data**

Coupling mechanisms Screw-lock  
 Weight N/A

**Environmental Data**

Temperature range -55°C to +165°C  
 RoHS compliant

**Material And Plating**

Piece Parts	Material	Plating
Centre contact	Beryllium Copper	Gold plating(Nickel underplated)
Body	Stainless Steel	Passivated
Insulator	PEI/PTFE	

**Packing**

Single or 100