

2.92mm Straight Panel Receptacle
Plug

K1GFA50-2382A/9XX

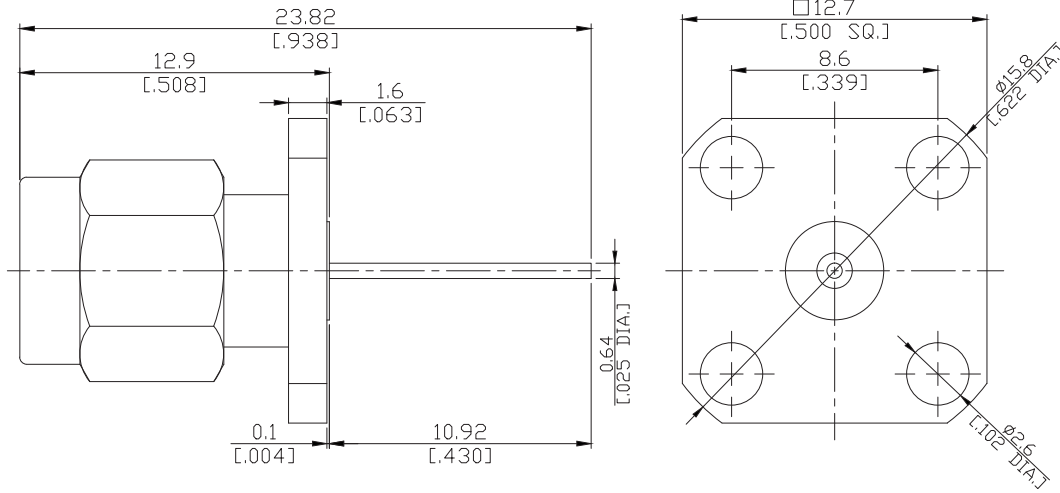

All dimensions are in mm [inch]

Interface

According to **MIL-STD-348A**

Electrical Data

Impedance **50 Ω**
 Frequency **DC to 50 GHz**
 VSWR **≤1.15**
 Return loss **≥23.127dB**

Mechanical Data

Coupling mechanisms **Screw-lock**
 Weight **N/A**

Environmental Data

Temperature range **-55°C to +165°C**
 RoHS **compliant**

Material And Plating

Piece Parts	Material	Plating
Centre contact	Beryllium Copper	Gold plating(Nickel underplated)
Body	Stainless Steel	Passivated
Insulator	PEI/PTFE	
Gasket	Silicone Rubber	
Coupling nut	Stainless Steel	Passivated

Packing

Single or 100